

TRUEBLEND™ HIGH HEAT MODELS



Model TBH500-4
High Heat

ACCURATE BLENDING FOR HIGH HEAT APPLICATIONS

TrueBlend high-temperature models allow processors running engineering plastics like ABS, nylon, polycarbonate and PET to blend these resins after they have been dried.

Until now, processors had to blend the material before drying, but by doing so ran the risk that some ingredients could separate out of the mix during the drying and conveying process.

Like all TrueBlend models, the new high-heat blenders feature a fully enclosed cabinet design assuring no pellet spillage and clean operation. Standard convenience features, such as wide access doors on each component bin, a hinged chassis access door and removable components in the mixing chamber reduce material waste and downtime during clean out.

DRY AIR BLANKET PREVENTS MOISTURE REGAIN

Models 100, 250, 500 and 900, which offer throughputs ranging from 450 to 3500 lbs/hr are available with two different high-temperature packages. One to handle temperatures from 160° to 250°F {71° to 121°C} for materials such as Nylons, ABS and PC. The second package handles temperature levels from 160° to 375°F {71° to 191°C}, including materials like PBT, PET and other polyesters.

Both temperature levels are available with an optional dry air blanket package. This option blankets the material compartments and the mixing chamber with dry air to prevent moisture regain during processing.

- **Blend accuracy to 1/2 of 1%**
Colorant and additive weights are held to within 0.5% of the requested ratio. The control automatically calibrates after each cycle and corrects for variations in material and dispensing.
- **Easy-to-use control**
Enter the percentages of the blend using the touch screen. The blender does the rest. The system automatically adds ingredients in the proper ratio and maintains the correct level of material in the mix chamber.
- **Convenient, no-tools clean out**
Electrically interlocked access doors provide fast, safe cleaning of component bins. The weigh bin, mix blade and mix chamber slide out for easy cleaning.
- **A package to fit your needs**
Two temperature levels are available. One for temperatures of 160° to 250°F {71° to 121°C} with the second package covering temperatures from 160° to 375°F {71° to 191°C}. A dry air blanket option introduces dry air into the material compartments and the mixing chamber from an external source to prevent moisture regain.



TRUEBLEND™ HIGH HEAT MODELS

FEATURES

A high heat blender to fit your application

Choose from two temperature levels. TBA models cover medium processing temperatures, those ranging up to 250°F {121°C}. TBH models handle higher processing temperatures - up to 375°F {191°C}. Both are specifically designed to accept engineered resins that have been dried prior to processing.

**TBA models
Medium temperature unit**

Designed for temperatures of more than 160°F and ranging to 250°F {71° to 121°C}. Materials such as Nylons, ABS and PC.

Some blender enhancements include:

- Safety disconnect relocated to the outside of the door.
- High temperature air cylinders and hosing.
- High temperature load cells.
- Standoff to isolate the power box from the chassis.

**TBH models
High temperature unit**

Handle temperatures ranging up to 375°F {191°C}. Materials such as PBT, PET and other polyesters.

Some blender enhancements include:

- Safety disconnect relocated to the outside of the door.
- High temperature air cylinders and hosing.
- High temperature load cells.
- High temperature level sensor.
- Standoff to isolate power box from chassis.
- High temperature glass-tempered sight glasses.
- Each access door opening has high temperature glass-tempered sight glasses.



Each access door opening has two round heat-treated sight glasses.

TBH models.

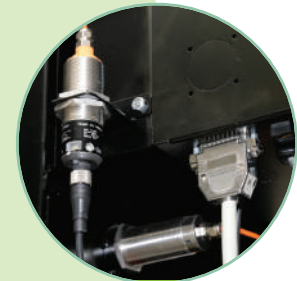

High temperature level sensors. Located on the rear of the unit.

TBH models.



High temperature, heat-treated sight glasses.

TBH models.



Safety disconnect has been relocated to the outside of the door.

TBH and TBA models.



OPTIONS

TRUEBLEND™ HIGH HEAT MODELS

Dry air blanket

Introduce hot dry air to the material bins of your blender with the dry air blanket option. This option blankets the material compartments and mixing chamber with dry air to prevent moisture regain during processing. Available on both the TBA and TBH models.

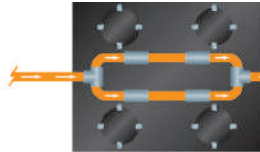
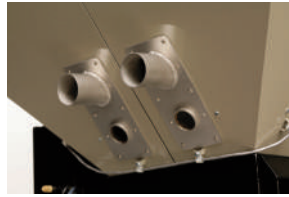

Adjusting the airflow
Isolation valves allow the air flow to be adjusted independently or completely shut-off depending on the need at each of the material bins.

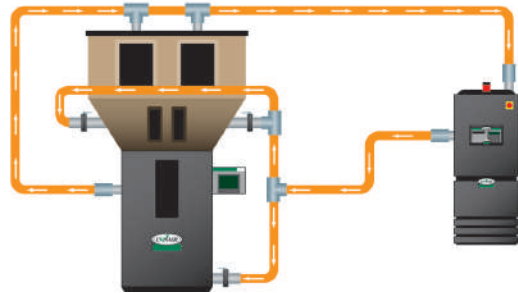

NOTE: This dry air source is not included with this package, but can be purchased separately from Conair.

Drain chute

The material drain chute readily installs to the chassis opening of the blender for fast and simple cleanout.



Minor component flow restrictor

Available on TBA/TBH models 250, 500 and 900 on bin positions three and/or four. (Generally used when feeding 1% or less of an ingredient.)

Major component flow restrictor

Available of TBA/TBH models 100, 250, 500 and 900 on bin positions one and/or two. (Generally used when feeding more than two minor ingredients.)

Air blow-off for mix chamber level sensor

This feature is integrated into the blender mix chamber to blow the dust and fines away from the sensing device and ensure accurate level sensor reading.

Remote mixer demand sensor

This sensor provides a fill-to level option in a surge bin or other material receptacle that sits below the blender.

Material level alarm control

Eliminate costly material shortage problems and machine downtime with this early warning system. The control monitors up to six levels of material at one blender. Individual switches can be adjusted to monitor high or low material levels.



MOUNTING INTERFACES

Dimensions shown in inches and (mm).

TBA and TBH100

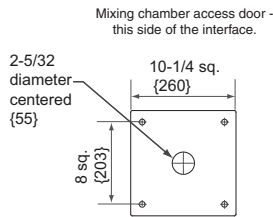

Mounting bolt hole size (4 holes) 9/16 inch (14.0 mm).
Predrilled 8 x 8 mounting pattern as standard.

TBA and TBH250

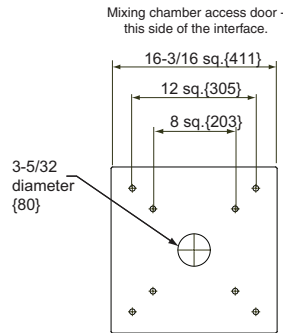

Mounting bolt hole size (8 holes) 9/16 inch (14.0 mm).
Predrilled 8 x 8 and 12 X 12 mounting pattern as standard.

TBA and TBH500

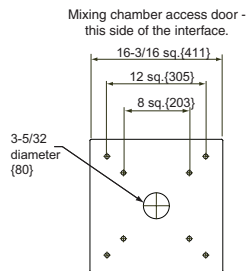

Mounting bolt hole size (8 holes) 9/16 inch (14.0 mm).
Predrilled 8 x 8 and 12 X 12 mounting pattern as standard.

TBA and TBH900

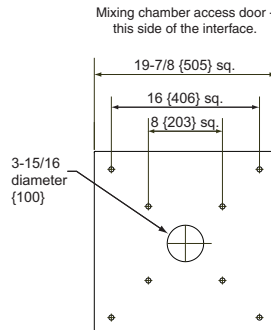

Mounting bolt hole size (8 holes) 9/16 inch (14.0 mm).
Predrilled 8 x 8 and 16 X 16 mounting pattern as standard.



SPECIFICATIONS

TRUEBLEND™ HIGH HEAT MODELS

Model TBA/TBH100

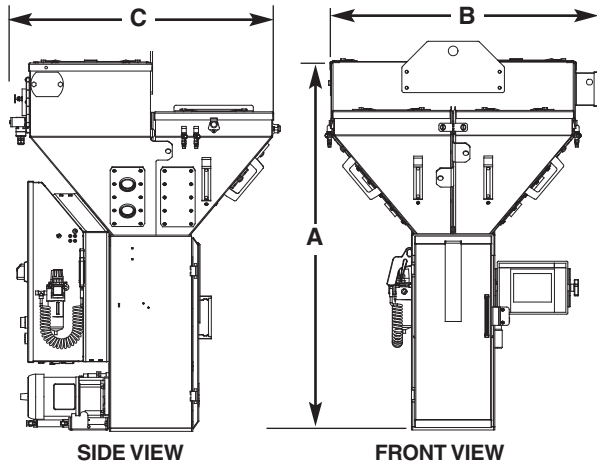

SIDE VIEW

FRONT VIEW

Model TBA/TBH250 - TBA/TBH900

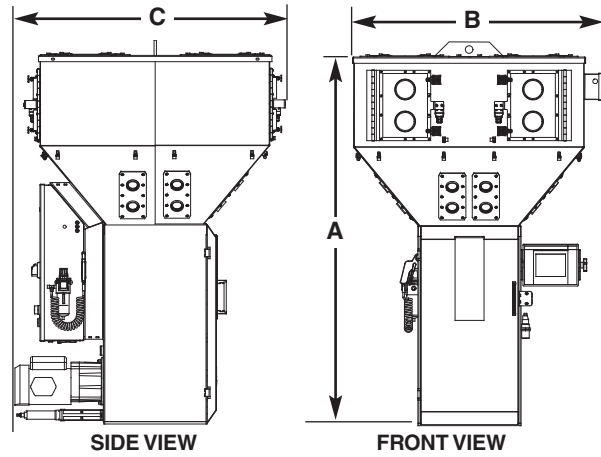

SIDE VIEW

FRONT VIEW

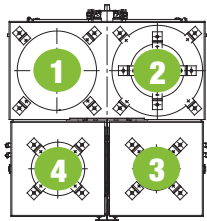

TOP VIEW TBA/H100

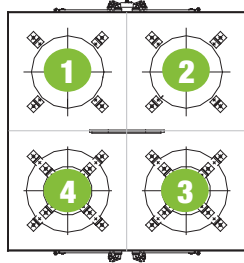

TOP VIEW TBA/H250-500

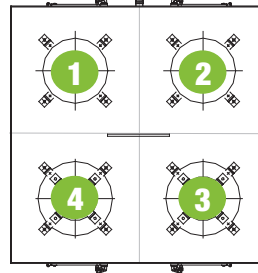

TOP VIEW TBA/H900

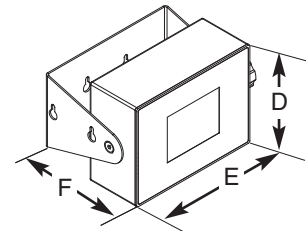

CONTROL

MODELS	TBA/TBH100	TBA/TBH250	TBA/TBH500	TBA/TBH900
Performance characteristics				
Batch size lbs {g}	2.2 {1000}	5.5 {2500}	11 {5000}	19.8 {9000}
Maximum throughput lbs/hr {kg/hr}*	400 {181}	950 {431}	1500 {680}	3500 {1588}
Bin capacity - main ingredient ft³ {liter}	0.6 {17}	1.6 {45.3}	2.7 {76.4}	4.4 {124.6}
Bin capacity - minor ingredient ft³ {liter}	0.3 {8}	1.6 {45.3}	2.7 {76.4}	4.4 {124.6}
Maximum number of materials	4	4	4	4
Number of vertical discharge valves	4	4	4	4
Number of major bin valves	2 - (60 mm)	2 - (60 mm)	2 - (100/60 mm)	2 - (100 mm)
Number of minor bin valves	2 - (20 mm)	2 - (30 mm)	2 - (30 mm)	2 - (60 mm)
Dimensions inches {mm}				
A - Height above mounting plate†	45.25 {1149}	57.50 {1461}	63.00 {1600}	74.75 {1896}
B - Width	30.25 {769}	36.50 {926}	40.13 {1026}	48.00 {1219}
C - Depth	32.75 {832}	40.83 {1037}	43.00 {1092}	51.00 {1296}
D - Control height	6.50 {165.1}	6.50 {165.1}	6.50 {165.1}	6.50 {165.1}
E - Control width	8.75 {222.3}	8.75 {222.3}	8.75 {222.3}	8.75 {222.3}
F - Control depth	6.75 {171.5}	6.75 {171.5}	6.75 {171.5}	6.75 {171.5}
Weight lbs {kg}				
Installed	160 {72}	320 {145}	400 {182}	550 {249}
Shipping	270 {122}	440 {120}	520 {236}	700 {318}
Voltage Total amps				
115V/1 phase/60 Hz	3.0	6.3	6.3	6.3
230V/1 phase/50 Hz	1.5	3.2	3.2	3.2
Compressed air requirements				
Discharge valves	90 psi @ 0.2 ft³/min. {6 bars @ 0.09 liters/sec}, 1/4 inch NPT fitting			
Maximum loader sizes‡				
20 inch loaders - number of loaders	NA	NA	NA	4
15 inch loaders - number of loaders	NA	4	4	NA
12 inch loaders - number of loaders	2	NA	NA	NA
8 inch loaders - number of loaders	2	NA	NA	NA

SPECIFICATION NOTES:

* Maximum throughput rates are based on 35 lb/ft³ pelletized material and using all of the standard valve sizes. Use of valve inserts will lower the rate shown.

Throughput rates are based on:

- A 4-position blender recipe of 20% regrind, 80% natural, 3% color and 2% additive material.

† The optional flow control valve will mount inside the chassis in the space of the manual slide valve. Conair recommends using the optional flow control valve when mounting the blender on a stand, surge bin or hopper.

‡ For loader mounting dimension details, refer to the corresponding TrueBlend blender specifications sheet.

Specifications may change without notice. Consult with a Conair representative for the most current information.

